

FEET PER:
SK-448
BOXED NOT REQ'D

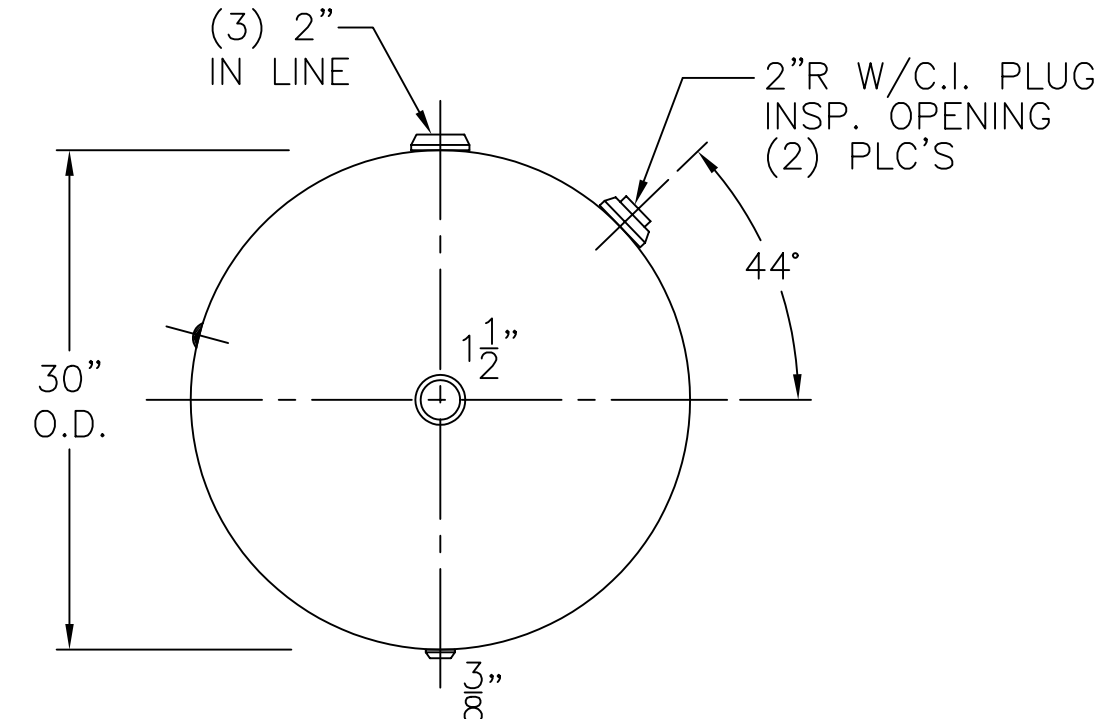

VIEW W/OUT SUPT.

NOTE: 1) HYDRO @ 260 PSIG. MIN.

HEADS	.166" SA-414-G 2.1 S.E.
	(.164" MIN.) JOGGLE
SHELL	GREEN STRIPE
	.165" SA-414-G
	M.A.W.P. 200 PSIG. @ 400 °F
	M.D.M.T. -20 °F @ 200 PSIG.
ASME. SECTION VIII DIV. 1, 2001 ADD 2003	
X-RAY: RT-4 SPOT L.S.	
GALLONS: 240	WT. 438 LBS.
SERIAL NO.	
N.B.	

H-240-F	REV. 2-5-04
	DATE: 10-29-85
FOR: HANSON STANDARD HORIZ. AIR TANK	
INSIDE: UNPAINTED	
OUTSIDE: PRIME	
BY: E.S.	SCALE: 3/4"=12"
ROY E. HANSON JR. MFG.	
1924 COMPTON AVE. LOS ANGELES, CA 90011	